

1

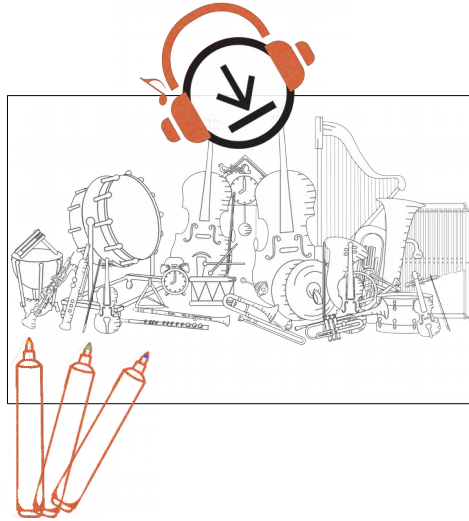

TOY'S COLORING SYMPHONY

2

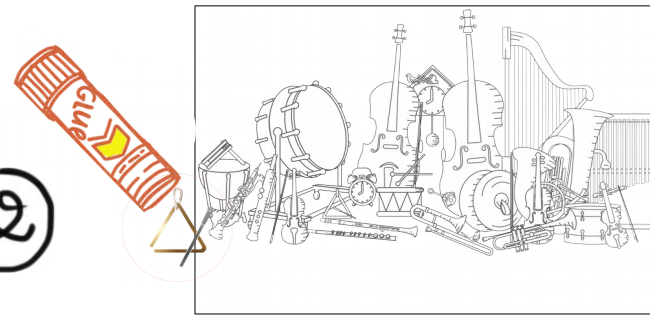

STICK AT THE RIGHT PLACE THE MUSICAL OBJECTS YOU HEAR WHEN LISTENING THE MUSIC

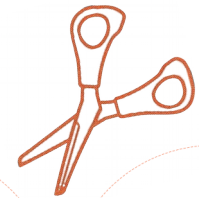
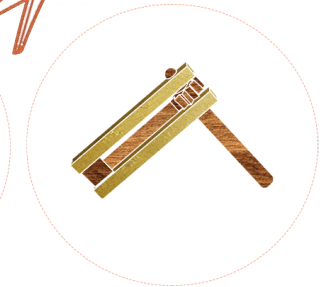
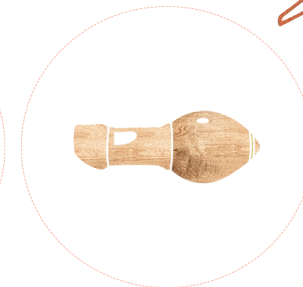
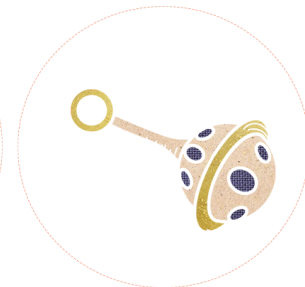
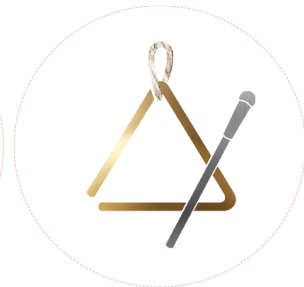

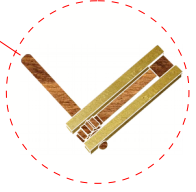
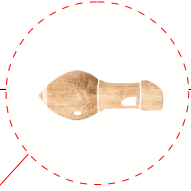
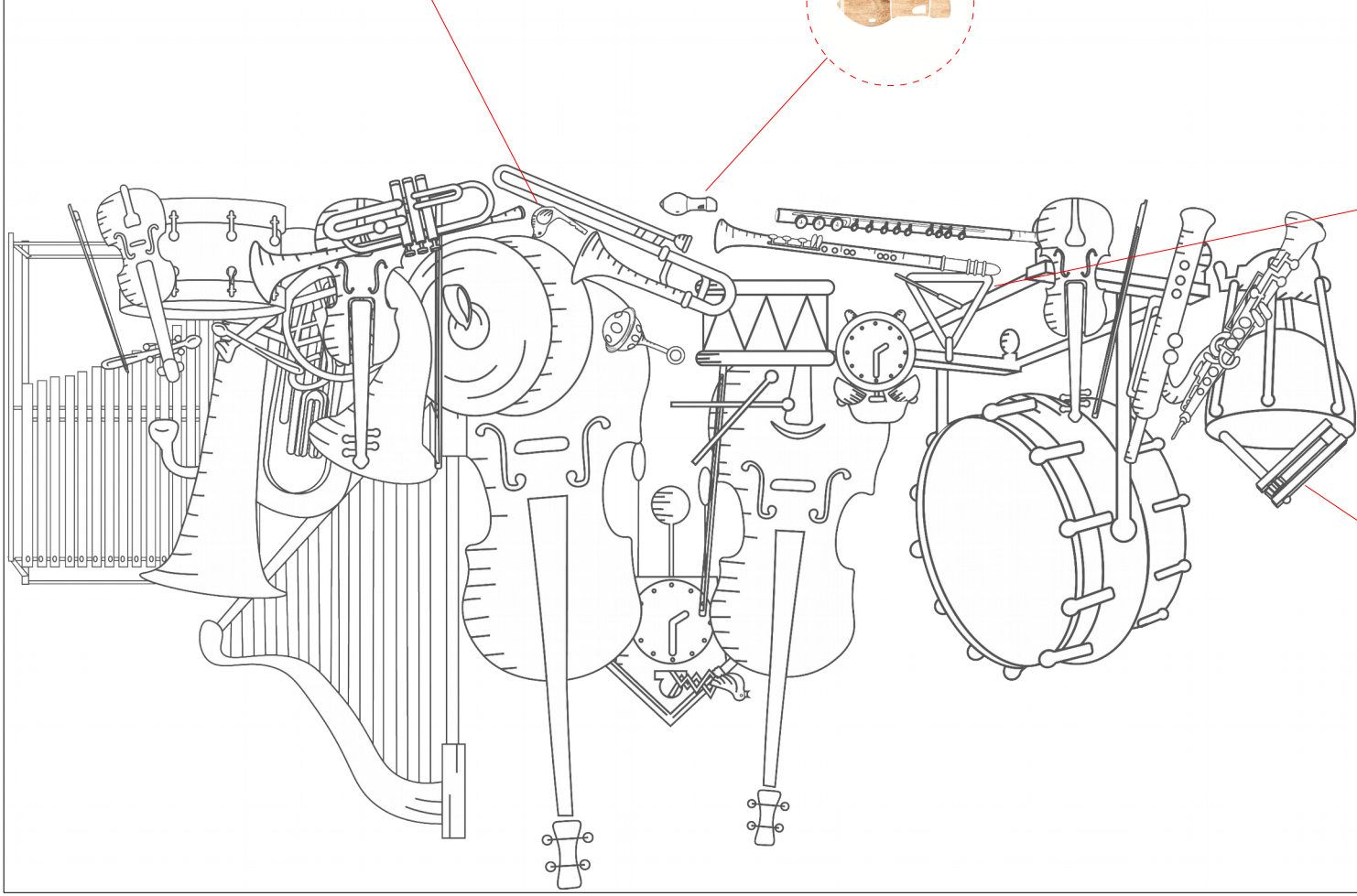

ANSWER