

1

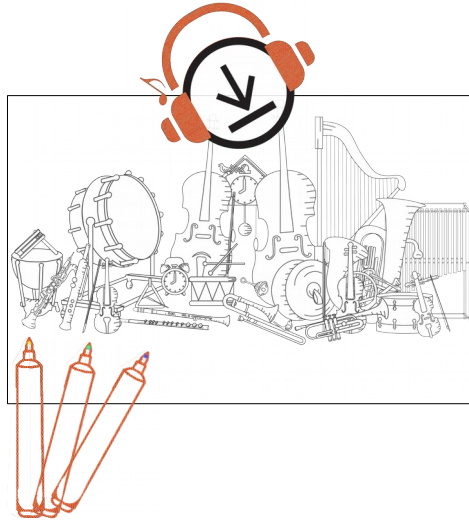

LA SYMPHONIE DES JOUETS

2

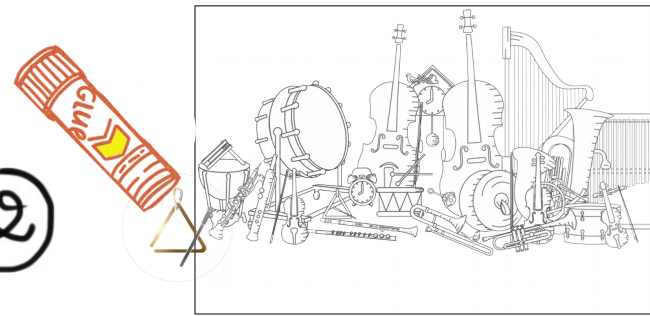

RETROUVE LES OBJETS CACHÉS ET COLLE À LA BONNE PLACE SUR LE COLORIAGE SEULEMENT CEUX QUE TU ENTENDS DANS LA MUSIQUE

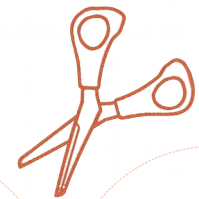
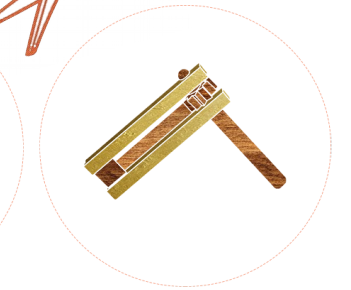
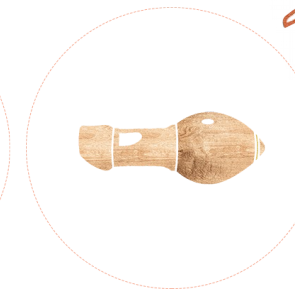
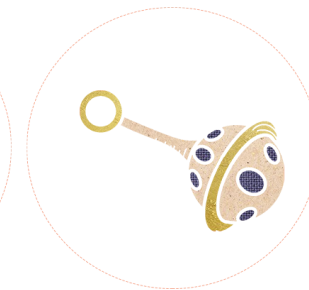

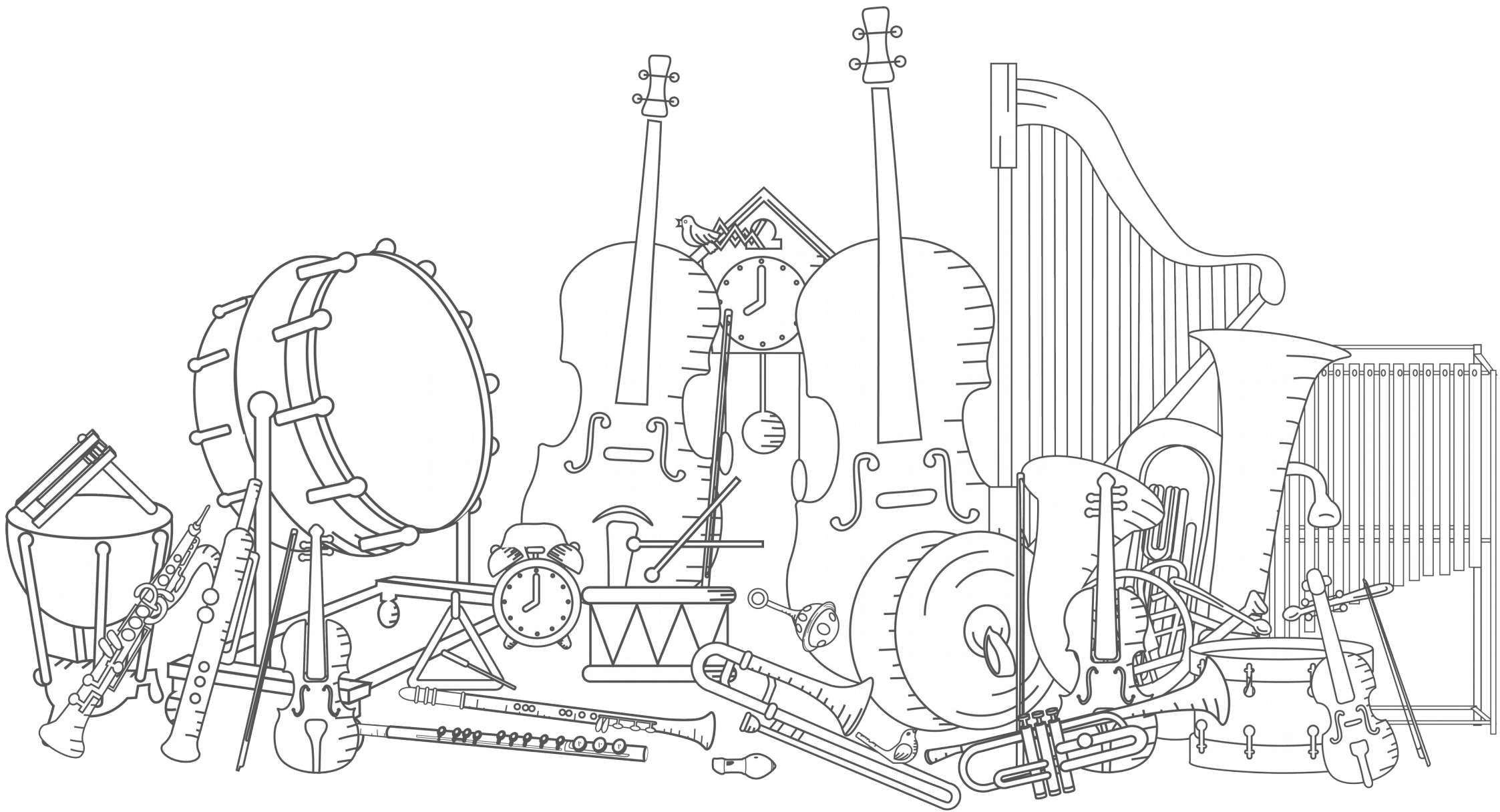

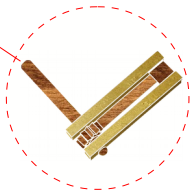
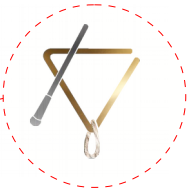
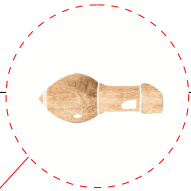
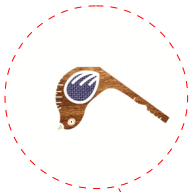
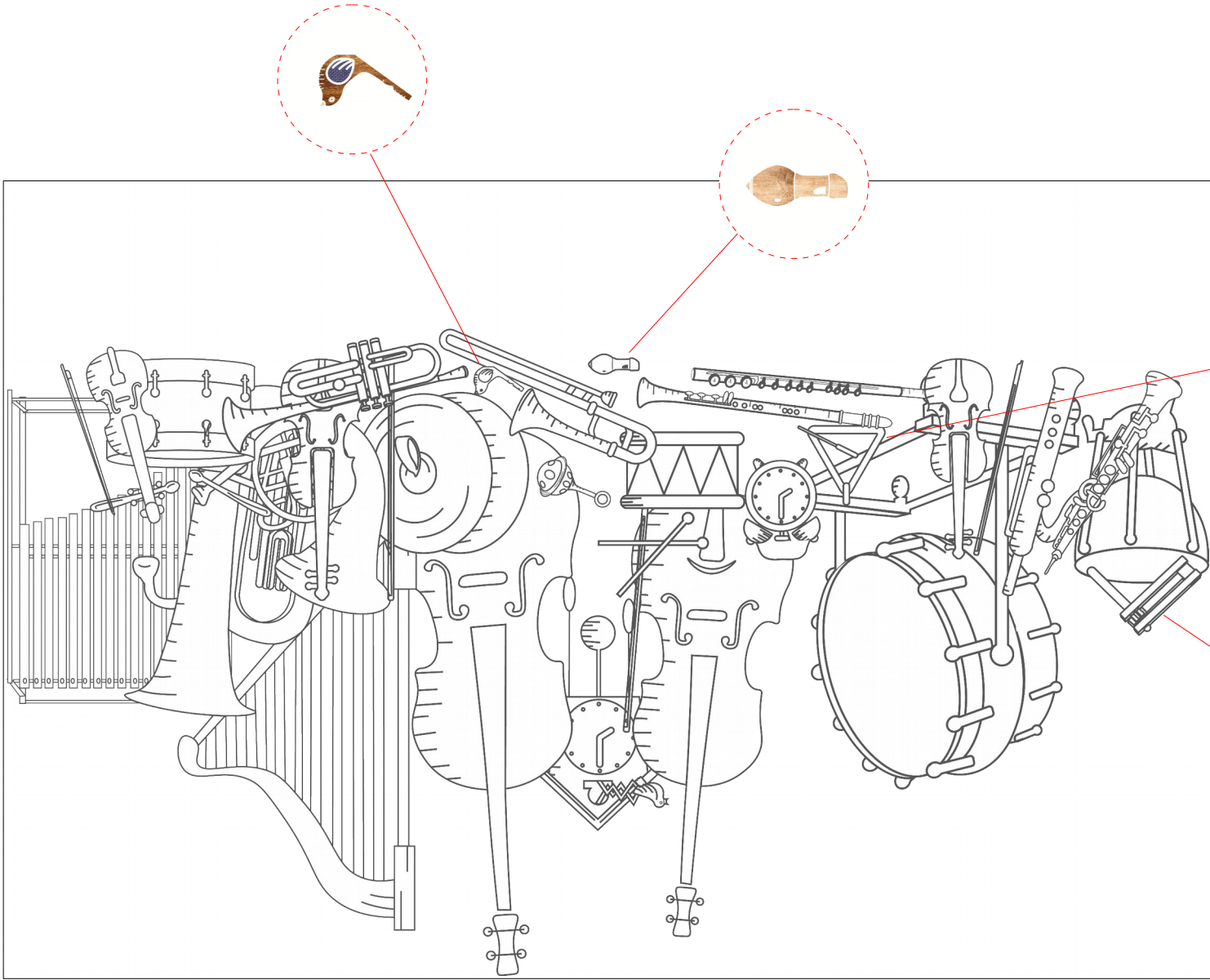

FEÜTILE REPONSE